

OVAL - 9.00 X 7.00 - 1 PCS.

SIEVE SIZE	DIA WT/PC	DIA MM	DIA PCS	DIA WT
2.5-3	0.010	1.30	22	0.22
		Total	22	0.22
		Gold Wt	GM	Ratio: 0

14 KT WT. - 2.50 GM
18 KT WT. - 3.00 GM



14 KT WT. - 2.50 GM
18 KT WT. - 3.00 GM
ROUND - 8.00 X 8.00 - 1 PCS.

7.50 MM



14 KT WT. - 2.50 GM
18 KT WT. - 3.00 GM
ROUND - 8.00 X 8.00 - 1 PCS.



ROUND - 8.00 X 8.00 - 1 PCS.

SIEVE SIZE	DIA WT/PC	DIA MM	DIA PCS	DIA WT
0-00	0.005	1.00	32	0.16
		Total	32	0.16

14 KT WT. - 2.50 GM
18 KT WT. - 3.00 GM



ROUND - 8.00 X 8.00 - 1 PCS.

SIEVE SIZE	DIA WT/PC	DIA MM	DIA PCS	DIA WT
00-000	0.005	0.90	28	0.14
2.5-3	0.010	1.30	22	0.22
		Total	50	0.36

14 KT WT. - 2.40 GM
18 KT WT. - 2.90 GM



14 KT WT. - 2.60 GM

18 KT WT. - 3.20 GM

CUSHION - 7.00 X 7.00 - 1 PCS.



PEAR - 6.00 X 4.00 - 2 PCS.
ROUND - 8.00 X 8.00 - 1 PCS.

14 KT WT. - 2.80 GM
18 KT WT. - 3.30 GM

15.90MM



7.20MM



US -7

1.70MM



26MM

2.13MM

PEAR-
11.10X6.90(2 CT.) PAR PCS.

18 KT WT -3.60GM.
14 KT WT -3.00GM
SILVER WT-2.40GM

SIEVE SIZE	DIA WT/PC	DIA MM	DIA PCS	DIA WT
0-00	0.005	1.00	30	0.15
1.5-2	0.008	1.20	24	0.19
Total			54	0.34

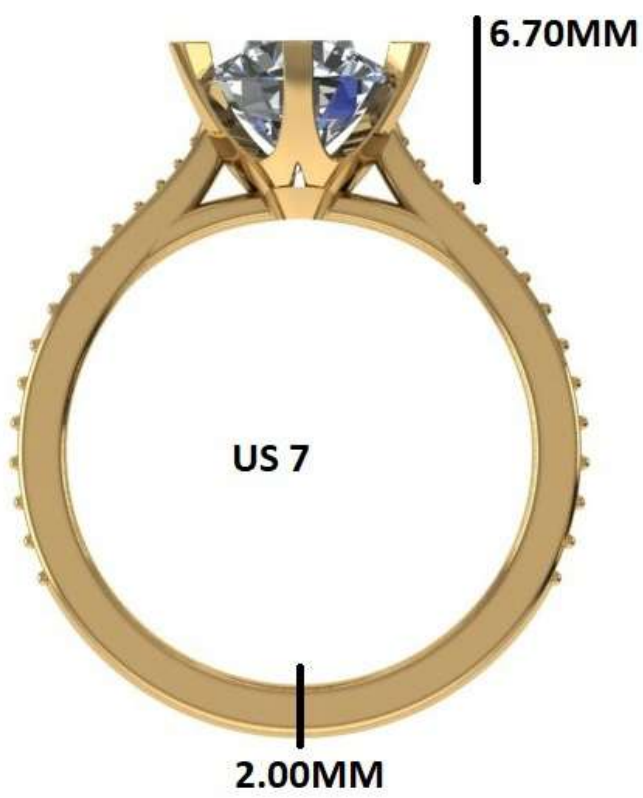

ROUND.- 8X8MM-1PCS(2.00CT.)

SIEVE SIZE	DIA WT/PC	DIA MM	DIA PCS	DIA WT
00-000	0.005	0.90	4	0.02
0-00	0.005	1.00	6	0.03
0-1	0.006	1.10	2	0.01
1.5-2	0.008	1.20	2	0.02
2.5-3	0.010	1.30	14	0.14
		Total	28	0.22

14KT WT.- 2.80GM
18KT WT.- 3.30GM
SILVER WT.- 2.20GM

10

8.00 MM



7.30 MM



1.70 MM



26.50 MM

2.00 MM

14 KT WT. - 2.60 GM

18 KT WT. - 3.00 GM

ROUND - 8.00 X 8.00 - 1 PCS.

SIEVE SIZE	DIA WT/PC	DIA MM	DIA PCS	DIA WT
00-000	0.005	0.90	22	0.11
		Total	22	0.11
		Gold Wt	GM	Ratio: 0



14 KT WT. - 2.60 GM

18 KT WT. - 3.00 GM

ROUND - 8.00 X8.00 -1 PCS.



RADIANT - 8.00 X 6.00 - 1 PCS.

SIEVE SIZE	DIA WT/PC	DIA MM	DIA PCS	DIA WT
1.5-2	0.008	1.20	26	0.21
		Total	26	0.21

14 KT WT. - 2.40 GM
18 KT WT. - 2.90 GM



ROUND - 8.00 X 8.00 - 1 PCS.

SIEVE SIZE	DIA WT/PC	DIA MM	DIA PCS	DIA WT
1.5-2	0.008	1.20	26	0.21
		Total	26	0.21

14 KT WT. - 2.20 GM
18 KT WT.- 2.60 GM



ROUND - 8.00 X 8.00 - 1 PCS.

SIEVE SIZE	DIA WT/PC	DIA MM	DIA PCS	DIA WT
00-000	0.005	0.90	26	0.13
1.5-2	0.008	1.20	26	0.21
		Total	52	0.34

14 KT WT. - 2.60 GM
18 KT WT. - 3.00 GM

11.40 MM



7.60 MM



US.7

1.70 MM

26.65 MM



2.00 MM

OVAL - 9.00 X 7.00 - 1 PCS.

SIEVE SIZE	DIA WT/PC	DIA MM	DIA PCS	DIA WT
00-000	0.005	0.90	28	0.14
		Total	28	0.14

14 KT WT. - 2.50 GM

18 KT WT. - 3.30 GM



ROUND DIA :- 8.00x8.00MM=1PCS. (2CT)
:-4.00x4.00MM=2PCS.

14KT WT:- 2.80GM
18KT WY:-3.40GM

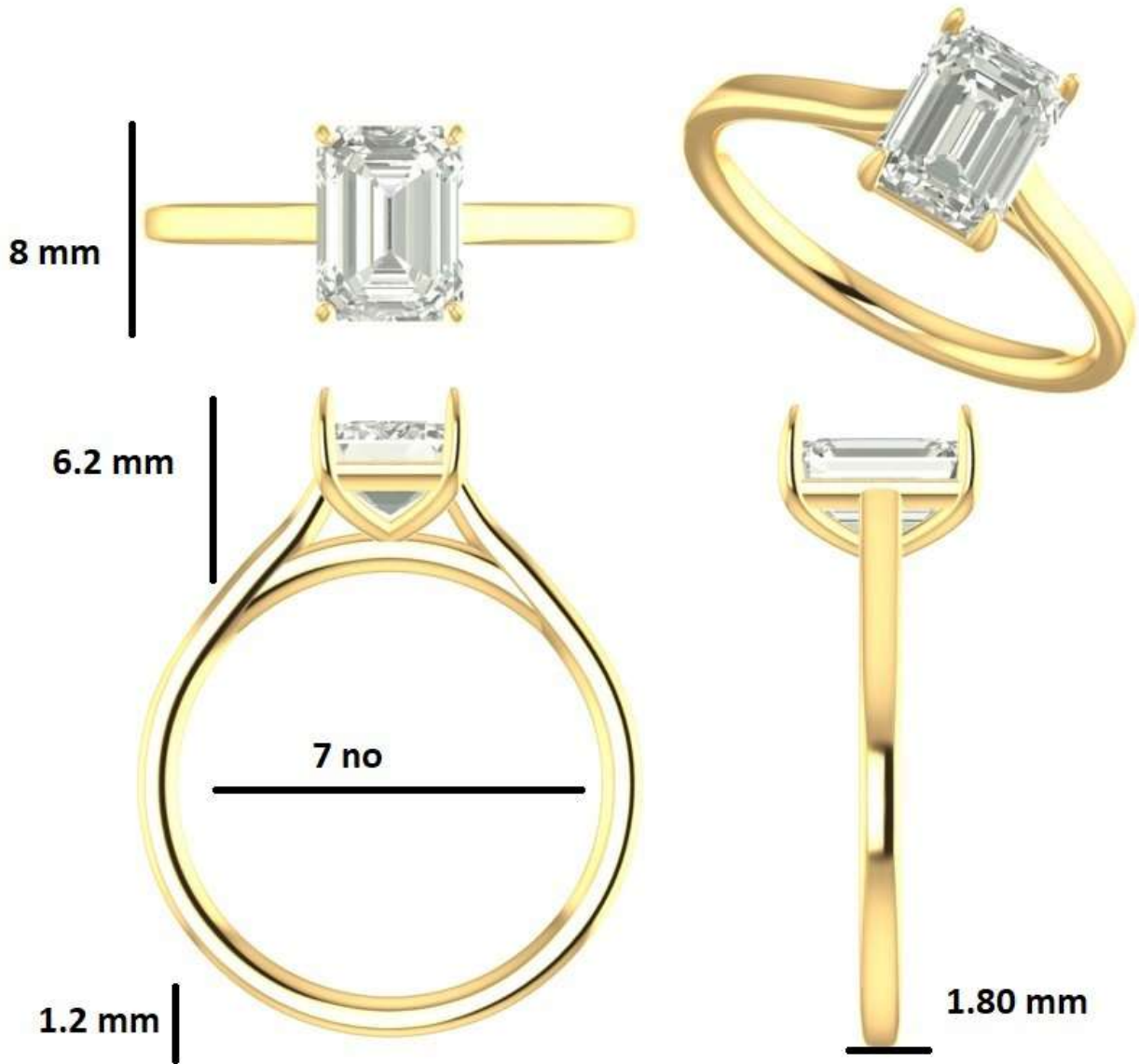

emerald - 8*6 mm - 1 (2ct)

14 k wt - 2.70 gm

18 k wt - 3.30 gm

7.30MM



7.40MM



1.70MM



26.90MM

2.00MM

14KT WT :- 2.20GM

18KT WT :- 2.60GM

ROUND DIA :-8.00x8.00MM=1PCS.(2CT)

:-1.20x1.30MM =22PCS.

19

11.5 mm



7 mm

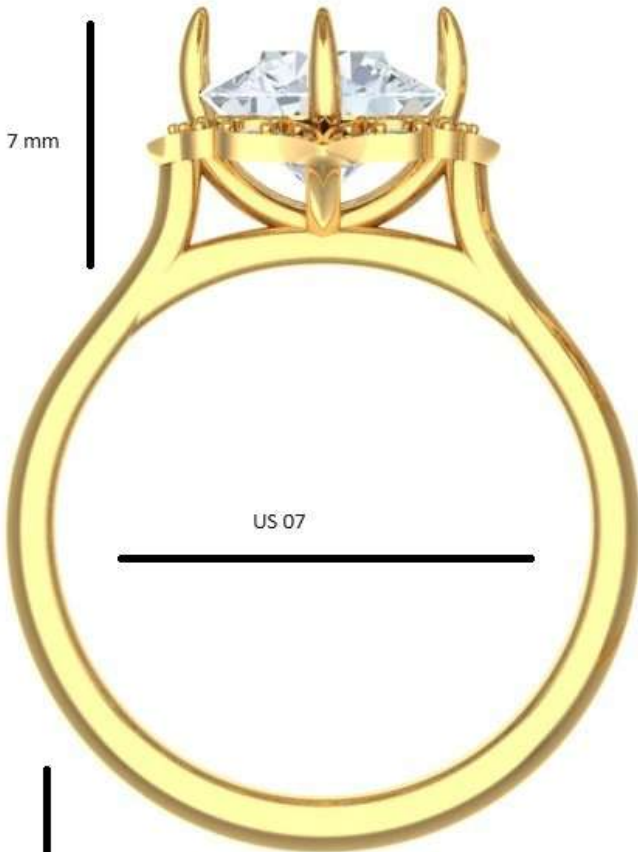

1.90 mm

1.90 mm

8.00 mm - 01 round

14 k wt - 2.20 gm

18 k wt - 2.70 gm

SIEVE SIZE	DIA WT/PC	DIA MM	DIA PCS	DIA WT
00-000	0.005	0.90	8	0.04
2.5-3	0.010	1.30	8	0.08
		Total	16	0.12



cushion - 7.00 x 7.00 - 1 pcs.

SIEVE SIZE	DIA WT/PC	DIA MM	DIA PCS	DIA WT
0-00	0.005	1.00	26	0.13
		Total	26	0.13

14 KT WT. - 2.60 GM
 18 KT WT. - 3.10 GM



**emerald - 8*6 mm - 01
(2 ct)**

**14 k wt - 2.70 gm
18 k wt - 3.30 gm**

7.50 MM



7.00 MM



US.7

1.70 MM



26.15 MM

2.00 MM

14 KT WT. - 2.50 GM
18 KT WT. - 3.00 GM
ROUND - 8.00 X 8.00 - 1 PCS.

9.00 MM



8.10 MM



US.7

1.70 MM



27.14 MM

2.00 MM

14 KT WT. - 2.60 GM

18 KT WT. - 3.10 GM

OVAL - 93.00 X 7.00 - 1 PCS.



ROUND - 8.00 X 8.00 - 1 PCS.

SIEVE SIZE	DIA WT/PC	DIA MM	DIA PCS	DIA WT
2.5-3	0.010	1.30	22	0.22
		Total	22	0.22

14 KT WT. - 2.50 GM
18 KT WT. - 3.00 GM

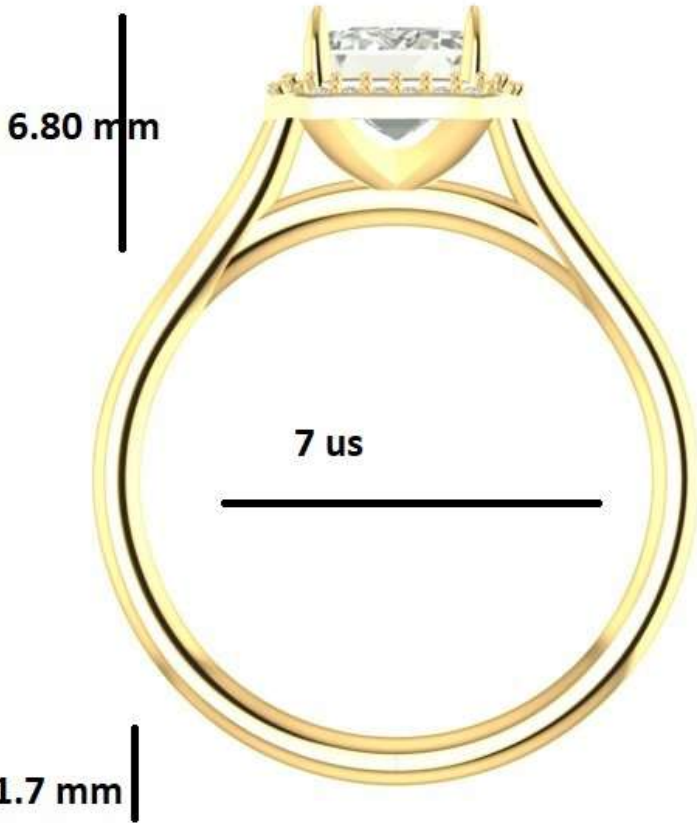

emerald 8*6 mm - 01 (2ct)

SIEVE SIZE	DIA WT/PC	DIA MM	DIA PCS	DIA WT
00-000	0.005	0.90	30	0.15
		Total	30	0.15

14 k wt - 2.70 gm
 18 k wt - 3.30 gm

8.50MM



11.00MM



US:-7

1.70MM



2.00MM

OVAL DIA:-9.00x7.00MM=1PCS.

SIEVE SIZE	DIA WT/PC	DIA MM	DIA PCS	DIA WT
3.5-4	0.012	1.40	22	0.26
		Total	22	0.26

14KT WT:-3.00GM

18KT WT:-3.70GM

9.80MM



9.50MM



1.70MM



2.00MM

ROUND DIA:-8.00x8.00MM=1PCS.

SIEVE SIZE	DIA WT/PC	DIA MM	DIA PCS	DIA WT
1.5-2	0.008	1.20	18	0.14
		Total	18	0.14

14KT WT:-2.70GM

18KT WT:-3.20GM



US:-7



ROUND DIA:-8.00x8.00MM=1PCS.
14KT WT:-3.00GM
18KT WT:-3.70GM

2.00MM

10.50MM



12.20MM



US:-7

1.70MM



2.00MM

ROUND DIA:-8.00x8.00MM=1PCS.

14KT WT:-2.60GM

18KT WT:-3.10GM

SIEVE SIZE	DIA WT/PC	DIA MM	DIA PCS	DIA WT
00-000	0.005	0.90	4	0.02
0-00	0.005	1.00	4	0.02
0-1	0.006	1.10	4	0.02
1.5-2	0.008	1.20	10	0.08
2.5-3	0.010	1.30	4	0.04
Total			26	0.18



CUSHION SQUARE DIA:-7.00x7.00MM=1PCS.

14KT WT:-2.80GM

18KT WT:-3.30GM

12.30MM



12.00MM



US:-7

1.70MM



2.00MM

OVAL DIA:-9.00x7.00MM=1PCS.

SIEVE SIZE	DIA WT/PC	DIA MM	DIA PCS	DIA WT
4.5-5	0.014	1.50	18	0.25
5.5-6	0.018	1.60	20	0.36
		Total	38	0.61

14KT WT:-3.30GM

18KT WT:-3.90GM

8.40MM



15.00MM



US:-7

1.70MM



2.00MM

ROUND DIA:-8.00x8.00MM=1PCS.

SIEVE SIZE	DIA WT/PC	DIA MM	DIA PCS	DIA WT
4.5-5	0.014	1.50	20	0.28
Total			20	0.28

14KT WT:-3.50GM
18KT WT:-4.20GM

12.90MM



12.50MM

US:-7

1.70MM



2.00MM

PEAR DIA:-9.00x6.00MM=1PCS.

SIEVE SIZE	DIA WT/PC	DIA MM	DIA PCS	DIA WT
2.5-3	0.010	1.30	19	0.19
		Total	19	0.19

14KT WT:-3.40GM

18KT WT:-4.00GM

10.80MM



12.40MM



US:7

1.70MM



2.00MM

CUSHION SQUARE DIA:-7.00x7.00MM=1PCS.

SIEVE SIZE	DIA WT/PC	DIA MM	DIA PCS	DIA WT
4.5-5	0.014	1.50	18	0.25
5.5-6	0.018	1.60	20	0.36
		Total	38	0.61

14KT WT:-3.10GM

18KT WT:-3.70GM

11.70MM



12.70MM



US:-7

1.70MM



2.00MM

ROUND DIA:-8.00x8.00MM=1PCS.

SIEVE SIZE	DIA WT/PC	DIA MM	DIA PCS	DIA WT
5.5-6	0.018	1.60	18	0.32
		Total	18	0.32

14KT WT:-3.50GM

18KT WT:-4.20GM

7.40 MM



7.20 MM



7 US

1.70 MM

14 KT WT. - 2.90 GM

18 KT WT. - 3.40 GM

ROUND - 8.00 - 8.00 - 1 PCS.

BAGUETTE - 4.50 X 3.00 - 2 PCS.



26.25 MM

2.00 MM

12.63 MM



7.65 MM



26.65 MM



2.00 MM

OVAL - 9.00 X 7.00 - 1 PCS.

SIEVE SIZE	DIA WT/PC	DIA MM	DIA PCS	DIA WT
1.5-2	0.008	1.20	23	0.18
		Total	23	0.18

14 KT WT. - 3.80 GM
18 KT WT. - 4.50 GM

8.10 MM



8.00 MM

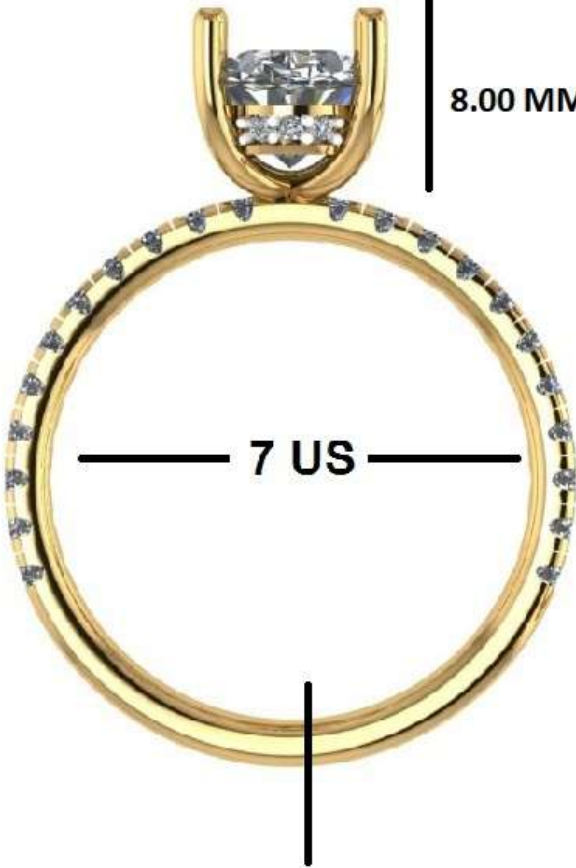

27.30 MM



2.00 MM

OVAL - 9.00 X 7.00 - 1 PCS.

SIEVE SIZE	DIA WT/PC	DIA MM	DIA PCS	DIA WT
0-00	0.005	1.00	12	0.06
5.5-6	0.018	1.60	22	0.40
		Total	34	0.46

14 KT WT. - 2.10 GM

18 KT WT. - 2.50 GM

7.70 MM



US.7

1.70 MM



28.00 MM

2.00 MM

ROUND - 8.00 X 8.00 - 1 PCS.

SIEVE SIZE	DIA WT/PC	DIA MM	DIA PCS	DIA WT
0-1	0.006	1.10	12	0.07
5.5-6	0.018	1.60	22	0.40
		Total	34	0.47

14 KT WT. - 2.20 GM
18 KT WT. - 2.60 GM

9.00 MM



7.85 MM



US.7

1.70 MM



27.30 MM

2.00 MM

OVAL - 9.00 X 7.00 - 1 PCS.

SIEVE SIZE	DIA WT/PC	DIA MM	DIA PCS	DIA WT
0-1	0.006	1.10	12	0.07
3.5-4	0.012	1.40	32	0.38
		Total	44	0.46

14 KT WT. - 2.40 GM
18 KT WT. - 3.00 GM

8.00 MM



8.70 MM



US.7

1.70 MM



27.75 MM

2.00 MM

ROUND - 8.00 X 8.00 - 1PCS.

SIEVE SIZE	DIA WT/PC	DIA MM	DIA PCS	DIA WT
0-1	0.006	1.10	12	0.07
3.5-4	0.012	1.40	32	0.38
		Total	44	0.45

14 KT WT. - 2.50 GM

18 KT WT. - 3.00 GM

9.60 MM



6.30 MM



7 US

1.70 MM



2.00 MM

DIA - 8.00 X 8.00 = 1 (2.00 CT)

14 KT - 2.30 GM

18 KT - 2.70 GM

7.78 MM



8.20 MM



US.7

1.70 MM



27.30 MM

2.00 MM

14 KT WT. - 2.70 GM

18 KT WT. - 3.20 GM

ROUND - 8.00 X 8.00 - 1 PCS.

8.00 MM



7.30 MM



US.7

1.7 MM

26.40 MM



2.00 MM

14 KT WT. - 2.60 GM
18 KT WT. - 3.15 GM
OVAL - 9.00 X 7.00 - 1 PCS.

7.65 MM



7.15 MM

US.7

1.70 MM



26.35 MM

2.00 MM

14 KT WT. - 3.40 GM
18 KT WT. - 4.00 GM
ROUND - 6.00 X 6.00 - 2 PCS.
8.00 X 8.00 - 1 PCS.

11.25 MM



8.15 MM



US.7

1.70 MM



27.15 MM

2.00 MM

ROUND - 7.80 X 7.80 - 1 PCS.

SIEVE SIZE	DIA WT/PC	DIA MM	DIA PCS	DIA WT
2.5-3	0.010	1.30	21	0.21
		Total	21	0.21

14 KT WT. 3.70 GM
18 KT WT. - 4.40 GM

7.66 MM



7.35 MM



1.70 MM



26.55 MM

2.00 MM

14 KT WT. - 3.80 GM

18 KT WT. - 4.50 GM

ROUND - 8.00 X 8.00 - 1 PCS.

6.00 X 6.00 - 2 PCS.

11.40 MM



8.00 MM



US.7

1.70 MM



27.00 MM

2.00 MM

PRINCESS - 7.00 X 7.00 - 1 PCS.

SIEVE SIZE	DIA WT/PC	DIA MM	DIA PCS	DIA WT
0-1	0.006	1.10	24	0.14
1.5-2	0.008	1.20	4	0.03
		Total	28	0.18

14 KT WT. - 4.20 GM

18 KT WT. - 5.10 GM

10.30 MM



9.15 MM



28.20 MM



2.00 MM

14 KT WT. - 3.20 GM
18 KT WT. - 3.80 GM
ROUND - 8.00 X 8.00 - 1PCS.

12.40MM



9.30MM



US:-7

1.70MM



2.00MM

OVAL DIA:-9.00x7.00MM=1PCS.(2CT)
 14KT WT:-2.90GM
 18KT WT:-3.50GM

SIEVE SIZE	DIA WT/PC	DIA MM	DIA PCS	DIA WT
1.5-2	0.008	1.20	22	0.18
2.5-3	0.010	1.30	24	0.24
		Total	46	0.42

52



SIEVE SIZE	DIA WT/PC	DIA MM	DIA PCS	DIA WT
5.5-6	0.018	1.60	15	0.27
		Total	15	0.27

14 k wt - 2.70 gm
18 k wt - 3.30 gm

8.10MM



6.50MM



1.70MM



2.00MM

OVAL.

9X7MM-1PCS

SIEVE SIZE	DIA WT/PC	DIA MM	DIA PCS	DIA WT
0-00	0.005	1.00	34	0.17
		Total	34	0.17

14KT WT.-2.30GM

18KT WT.-2.80GM

13.20MM



5.30MM



US:-7

1.70MM



2.00MM

OVAL DIA:-9.00x7.00MM=1PCS.

SIEVE SIZE	DIA WT/PC	DIA MM	DIA PCS	DIA WT
00-000	0.005	0.90	12	0.06
2.5-3	0.010	1.30	46	0.46
		Total	58	0.52

14KT WT:-2.80GM

18KT WT:-3.30GM



**PEAR.
12X8MM-1PCS (3CT.)**

SIEVE SIZE	DIA WT/PC	DIA MM	DIA PCS	DIA WT
4.5-5	0.014	1.50	22	0.31
6-6.5	0.021	1.70	20	0.42
		Total	42	0.73

**14KT WT.-3.00GM
18KT WT.-3.60GM**



3.50MM



ROUND :- 1.30x1.30 = 39 PCS
8.00x8.00 = 1 PCS

GOLD WT :-
14 KT :- 4.20 GM
18 KT :- 4.90 GM

11.90MM



3.80MM

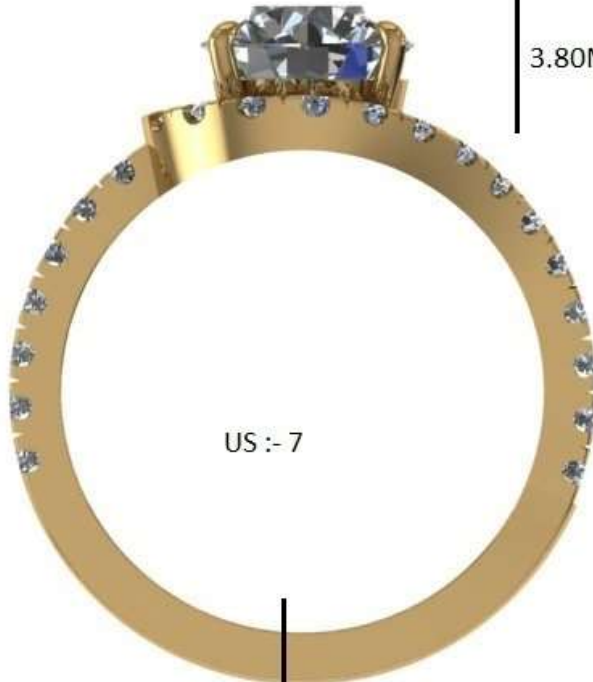

US :- 7

1.70MM



23.90MM

2.00MM

ROUND :- 8.00x8.00 = 1 PCS
1.70x1.70 = 36 PCS

GOLD WT :-
14 KT :- 3.55 GM
18 KT :- 4.25 GM

6.80MM



18

6.30MM

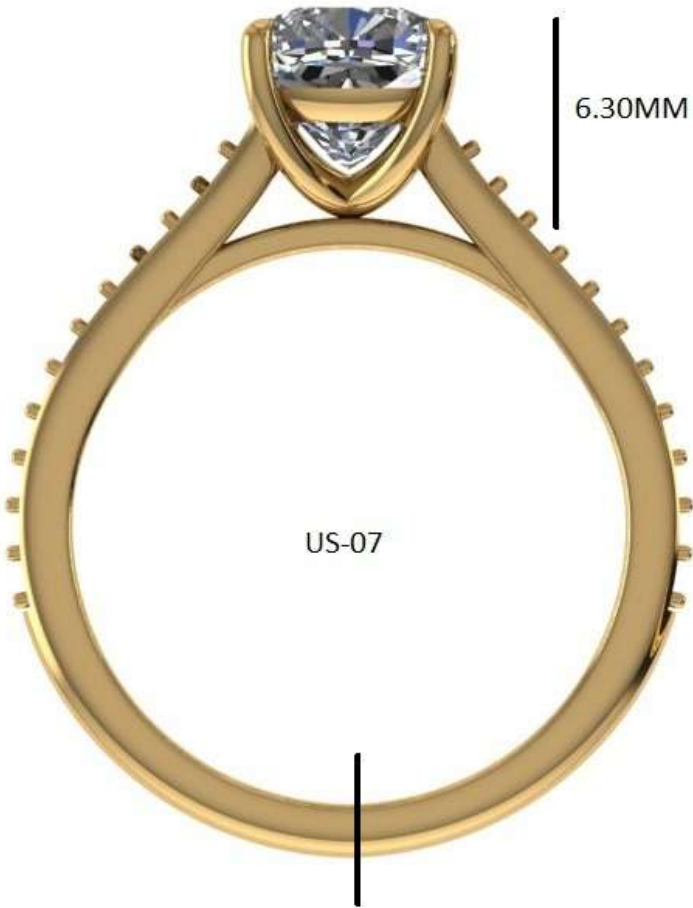

US-07

1.70MM

CUSHION SQUARE DIA :- 7.00x7.00MM=1PCS.(2CT)
ROUND DIA :- 1.30x1.30MM=24PCS.



2.00MM

14KT WT:-2.30GM
18KT WT:-2.80GM



ROUND DIA:-7.00x7.00MM=1PCS.
 14KT WT:-2.40GM
 18KT WT:-2.80GM

SIEVE SIZE	DIA WT/PC	DIA MM	DIA PCS	DIA WT
1.5-2	0.008	1.20	2	0.02
2.5-3	0.010	1.30	26	0.26
		Total	28	0.28



PEAR.
11.10X6.90MM-1PCS (2CT.)

14KT WT.-2.40GM
18KT WT.-3.00GM

7.70 MM



6.30 MM



7 US

1.70 MM



2.00 MM

14 KT - 2.30 GM

18 KT - 2.80 GM

OVAL DIA - 9.00 X 7.00=1 PCS.(2.00 CT)



ROUND - 8.00 X 8.00 - 1 PCS (2 CT)

SIEVE SIZE	DIA WT/PC	DIA MM	DIA PCS	DIA WT
2.5-3	0.010	1.30	24	0.24
		Total	24	0.24

14 KT WT. - 2.00 GM
18 KT WT. - 2.40 GM
SILVER WT. - 1.60 GM

10.90MM



7.70MM



US-7

1.70MM

ROUND DIA :-8.00x8.00MM=1PCS.(2CT)

1.30x1.30MM=22PCS.

1.00x1.00MM=24PCS.



2.00MM

14KT:-2.70GM

18KT;-3.24GM

10.30MM



5.80MM



US-7

1.70MM



2.00MM

CUSHION SQUARE DIA :-7:00x7:00MM=1PCS.(2CT)

ROUND DIA:-1.20x1.20MM=20PCS.

14KT WT:-2.80GM

18KT WT:-3.40GM



1.80MM

ROUND.- 6.50X6.50MM-1PCS (1.00CT.)

SIEVE SIZE	DIA WT/PC	DIA MM	DIA PCS	DIA WT
0-1	0.006	1.10	12	0.07
2.5-3	0.010	1.30	33	0.33
5.5-6	0.018	1.60	2	0.04
		Total	47	0.44

14KT WT.- 2.20GM
18KT WT.- 2.60GM
SILVER WT.- 1.80GM



ROUND.
5X5MM-2PCS (0.50CT.) PER PCS
6.50X6.50MM-1CPS (1CT.)

SIEVE SIZE	DIA WT/PC	DIA MM	DIA PCS	DIA WT
4.5-5	0.014	1.50	18	0.25
6-6.5	0.021	1.70	13	0.27
		Total	31	0.53

14KT WT.-3.40GM.
18KT WT.-4.10GM

10.30MM



6.10MM



US:-7

1.70MM



2.00MM

CUSHION SQUARE DIA:-7.00x7.00MM=1PCS.(2CT)
 14KT WT:-2.70GM
 18KT WT:-3.30GM

SIEVE SIZE	DIA WT/PC	DIA MM	DIA PCS	DIA WT
1.5-2	0.008	1.20	20	0.16
2.5-3	0.010	1.30	26	0.26
		Total	46	0.42

9.10MM



9.00MM



US:-7

1.70MM



2.00MM

EMERALD DIA:-8.50x6.50MM=1PCS.(2CT)

14KT WT:-2.60GM

18KT WT:-3.20GM

6.60MM



5.90MM



1.70MM

14KT WT:-2.40MM
18KT WT:-2.80GM

25.60MM



2.00MM

ROUND DIA :-8.00x8.00MM=1PCS.(2CT)

7.70MM



6.30MM

1.70MM



26.00MM

2.00MM

PRINCESS DIA :- 7.00x7.00MM=1PCS.(2CT)
ROUND DIA :-1.30x1.30MM=22PCS.

14KT WT:-2.20GM
18KT WT:-2.60GM



71



ROUND..7X7MM-1PCS (1.30CT.)

SIEVE SIZE	DIA WT/PC	DIA MM	DIA PCS	DIA WT
00-000	0.005	0.90	8	0.04
0-00	0.005	1.00	4	0.02
2.5-3	0.010	1.30	22	0.22
3.5-4	0.012	1.40	16	0.19
		Total	50	0.47

14KT WT.-2.20GM
18KT WT.-2.60GM



OVAL.

9X7MM-1PCS (2CT.)

SIEVE SIZE	DIA WT/PC	DIA MM	DIA PCS	DIA WT
00-000	0.005	0.90	8	0.04
0-00	0.005	1.00	4	0.02
1.5-2	0.008	1.20	19	0.15
3.5-4	0.012	1.40	22	0.26
		Total	53	0.48

14KT WT.-2.40GM

18KT WT.-2.80GM



2.00MM

CUSHION SQUARE.

5.5X5.5MM-1PCS (1CT.)

SIEVE SIZE	DIA WT/PC	DIA MM	DIA PCS	DIA WT
2.5-3	0.010	1.30	24	0.24
3.5-4	0.012	1.40	14	0.17
		Total	38	0.41

14KT WT.-2.20GM

18KT WT.-2.60GM



OVAL.- 9X7MM- 1PCS (2.00CT.)

SIEVE SIZE	DIA WT/PC	DIA MM	DIA PCS	DIA WT
1.5-2	0.008	1.20	20	0.16
		Total	20	0.16

14KT WT.- 2.60GM
18KT WT.- 3.10GM
SILVER WT.- 2.00GM

10.30 MM



6.80 MM



US .7

1.70 MM



2.00 MM

ROUND - 7.00 X 7.00 - 1 PCS.(1.30 CT)

SIEVE SIZE	DIA WT/PC	DIA MM	DIA PCS	DIA WT
3.5-4	0.012	1.40	16	0.19
		Total	16	0.19

14 KT WT. - 2.40 GM

18 KT WT. - 2.90 GM



**CUSHION SQUARE.
7X7MM-1PCS (2CT.)**

SIEVE SIZE	DIA WT/PC	DIA MM	DIA PCS	DIA WT
4.5-5	0.014	1.50	17	0.24
		Total	17	0.24

**14KT WT.-3.30GM
18KT WT.-4.00GM**

8.90 MM



6.60 MM

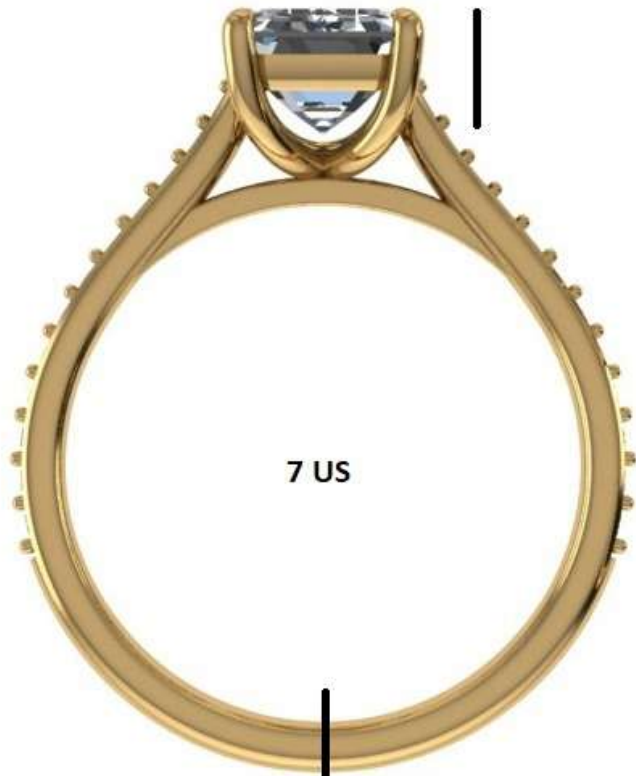

7 US

1.70 MM



2.00 MM

14 KT - 2.60 GM
18 KT - 3.00 GM

DIA - 8.50X 6.50 = 1 PCS.

SIEVE SIZE	DIA WT/PC	DIA MM	DIA PCS	DIA WT
2.5-3	0.010	1.30	24	0.24
		Total	24	0.24



**ROUND.
8X8MM-1PCS (2CT.)**

SIEVE SIZE	DIA WT/PC	DIA MM	DIA PCS	DIA WT
5.5-6	0.018	1.60	20	0.36
7.5-8	0.035	2.00	2	0.07
		Total	22	0.43

**14KT WT.-2.80GM
18KT WT.-3.20GM**

7.30 MM



7.00 MM

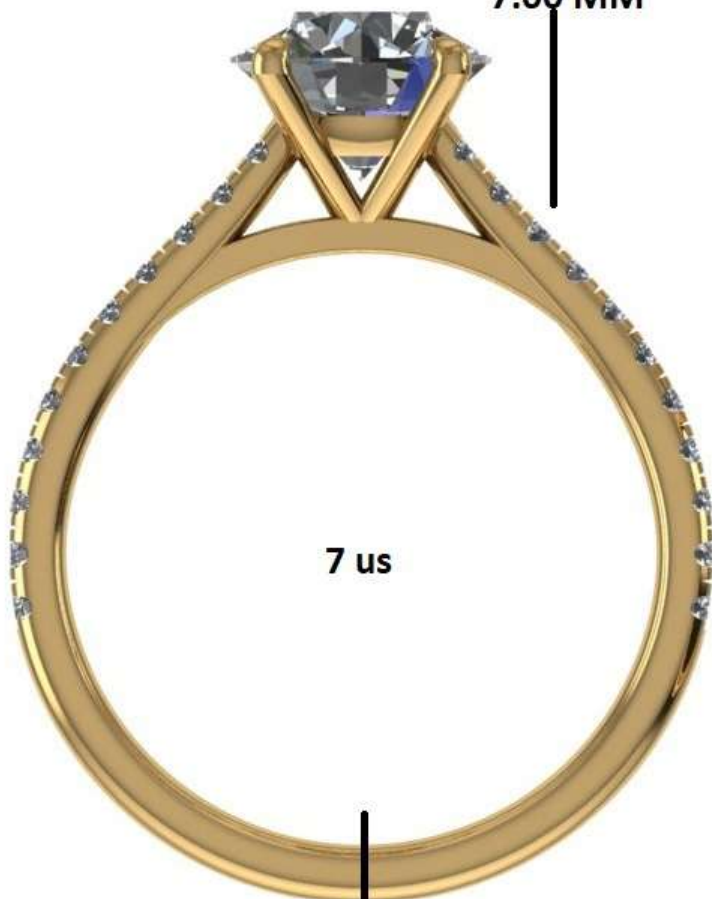

7 us

1.70 MM



2.00 MM

DIA - 8.00 X 8.00 = 1 PCS.

SIEVE SIZE	DIA WT/PC	DIA MM	DIA PCS	DIA WT
2.5-3	0.010	1.30	22	0.22
		Total	22	0.22

14 KT - 2.00 GM
18 KT - 2.60 GM



**PRINCESS.
7X7MM-1PCS (2CT.)**

SIEVE SIZE	DIA WT/PC	DIA MM	DIA PCS	DIA WT
2.5-3	0.010	1.30	20	0.20
		Total	20	0.20

**14KT WT.-3.20GM
18KT WT.-3.90GM**

9.00MM



7.00MM



US :-7

1.90MM



2.20MM

PEAR.
6X4MM-2PCS (0.50CT.) PER PCS
OVAL.
9X7MM-1PCS (2CT.)

14KT WT.-3.30GM
18KT WT.-4.00GM



2.00MM

**ROUND.
8X8MM-1PCS (2CT.)**

SIEVE SIZE	DIA WT/PC	DIA MM	DIA PCS	DIA WT
2.5-3	0.010	1.30	21	0.21
		Total	21	0.21

**14KT WT.-3.20GM
18KT WT.-3.80GM**



ROUND.

1.70MM

8X8MM-1PCS (2CT.)

2.40MM

14KT WT.-3.30GM
18KT WT.-4.00GM

SIEVE SIZE	DIA WT/PC	DIA MM	DIA PCS	DIA WT
0-00	0.005	1.00	4	0.02
0-1	0.006	1.10	4	0.02
1.5-2	0.008	1.20	4	0.03
2.5-3	0.010	1.30	21	0.21
3.5-4	0.012	1.40	32	0.38
		Total	65	0.67



**ROUND.
8X8MM-1PCS (2CT.)**

SIEVE SIZE	DIA WT/PC	DIA MM	DIA PCS	DIA WT
4.5-5	0.014	1.50	18	0.25
5.5-6	0.018	1.60	22	0.40
		Total	40	0.65



**OVAL.
9X7MM-1PCS (2CT.)**

SIEVE SIZE	DIA WT/PC	DIA MM	DIA PCS	DIA WT
1.5-2	0.008	1.20	23	0.18
		Total	23	0.18

**14KT WT.-3.80GM
18KT WT.-4.50GM**



MARQUISE - 13X6.50MM-1PCS (2.00CT.)

SIEVE SIZE	DIA WT/PC	DIA MM	DIA PCS	DIA WT
5.5-6	0.018	1.60	40	0.72
		Total	40	0.72

14KT WT.-4.00GM
18KT WT.- 4.90GM
SILVER WT.- 3.30GM



MARQUISE.

13X6.50MM-1PCS (2CT.)

SIEVE SIZE	DIA WT/PC	DIA MM	DIA PCS	DIA WT
5.5-6	0.018	1.60	20	0.36
		Total	20	0.36

14KT WT.-4.30GM

18KT WT.-5.20GM



**ROUND.
8X8MM-1PCS (2CT.)**

SIEVE SIZE	DIA WT/PC	DIA MM	DIA PCS	DIA WT
4.5-5	0.014	1.50	18	0.25
		Total	18	0.25

**14KT WT.-2.80GM
18KT WT.-3.40GM**



MARQUISE.
13X6.5MM-1PCS (2CT.)

SIEVE SIZE	DIA WT/PC	DIA MM	DIA PCS	DIA WT
0-00	0.005	1.00	32	0.16
		Total	32	0.16

14KT WT.-4.50GM
18KT WT.-5.40GM



MARQUISE - 13X6.50MM-1PCS (2.00CT.)

SIEVE SIZE	DIA WT/PC	DIA MM	DIA PCS	DIA WT
0-00	0.005	1.00	32	0.16
4.5-5	0.014	1.50	22	0.31
		Total	54	0.47

14KT WT.- 4.30GM
18KT WT.- 5.20GM
SILVER WT.-3.50GM

9.10 MM



7.60 MM



1.70 MM



4.60 MM

ROUND - 6.50 X 6.50 - 1 PCS.(1 CT)

SIEVE SIZE	DIA WT/PC	DIA MM	DIA PCS	DIA WT
0-00	0.005	1.00	60	0.30
2.5-3	0.010	1.30	18	0.18
		Total	78	0.48

14 KT WT. - 3.40 GM

18 KT WT. - 4.00 GM

10.10MM



7.00MM



US 7

1.70MM



2.30MM

PRINCESS - 7X7MM- (2.00CT.)

SIEVE SIZE	DIA WT/PC	DIA MM	DIA PCS	DIA WT
1.5-2	0.008	1.20	26	0.21
5.5-6	0.018	1.60	20	0.36
		Total	46	0.57

14KT WT.- 3.30GM
18KT WT.- 3.90GM
SILVER WT.- 2.60GM

12.20MM



6.50MM



7.-US

1.70MM

2.50MM

EMERALD.
8.50X6.50MM-1PCS (2CT.)

14KT WT.-3.60GM
18KT WT.-4.30GM

SIEVE SIZE	DIA WT/PC	DIA MM	DIA PCS	DIA WT
0-00	0.005	1.00	30	0.15
4.5-5	0.014	1.50	22	0.31
		Total	52	0.46

12.50MM



5.90MM



7 US

1.70MM



2.50MM

HEART.

8X8MM-1PCS (2CT.)

SIEVE SIZE	DIA WT/PC	DIA MM	DIA PCS	DIA WT
0-1	0.006	1.10	26	0.16
4.5-5	0.014	1.50	22	0.31
Total			48	0.46

14KT WT.-3.20GM

18KT WT.-3.90GM



PEAR.
10X6MM-1PCS (1.71CT.)

SIEVE SIZE	DIA WT/PC	DIA MM	DIA PCS	DIA WT
0-1	0.006	1.10	24	0.14
		Total	24	0.14

14KT WT.-3.20GM
18KT WT.-3.80GM



**HEART.
8X8MM-1PCS (2CT.)**

SIEVE SIZE	DIA WT/PC	DIA MM	DIA PCS	DIA WT
0-1	0.006	1.10	26	0.16
		Total	26	0.16

**14KT WT.-3.70GM
18KT WT.-4.50GM**



ROUND - 8.00 X 8.00 - 1 PCS. (2CT)

SIEVE SIZE	DIA WT/PC	DIA MM	DIA PCS	DIA WT
3.5-4	0.012	1.40	22	0.26
		Total	22	0.26

14 KT WT. - 2.30 GM
18 KT WT. - 2.740 GM

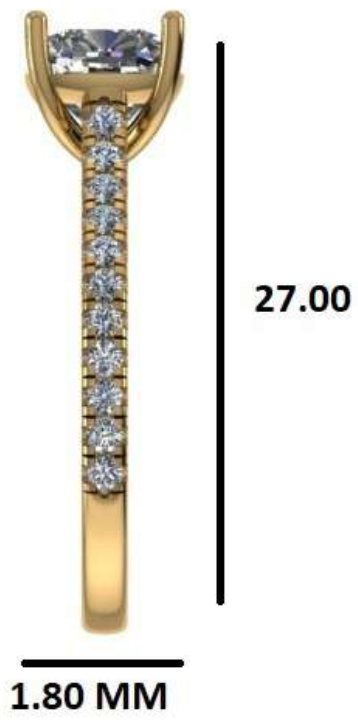

**CUSHION -
7.00 X 7.00 - 1 PCS.**

SIEVE SIZE	DIA WT/PC	DIA MM	DIA PCS	DIA WT
5.5-6	0.018	1.60	22	0.40
		Total	22	0.40

14 KT WT. - 2.20 GM

18 KT WT. - 2.60 GM

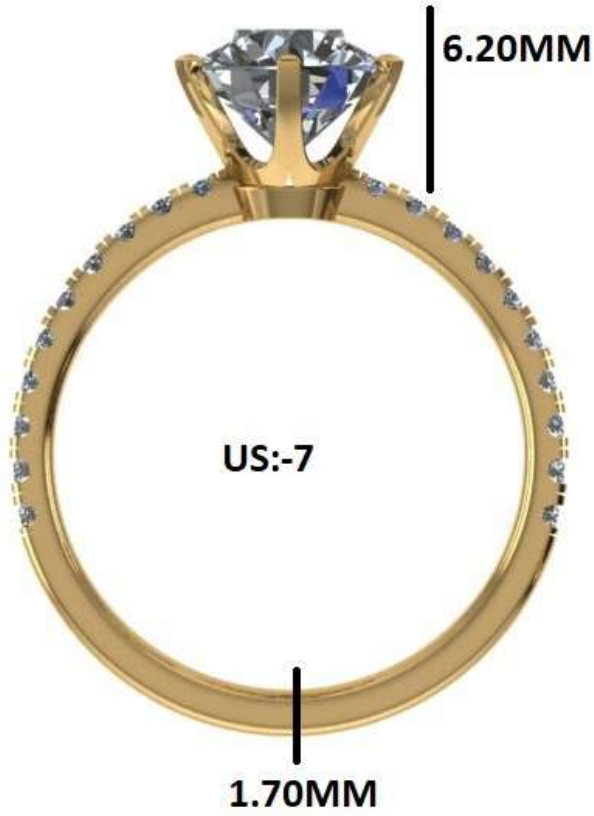

**ROUND.
8X8MM-1PCS (2CT.)**

SIEVE SIZE	DIA WT/PC	DIA MM	DIA PCS	DIA WT
3.5-4	0.012	1.40	20	0.24
		Total	20	0.24

**14KT WT.-1.70GM
18KT WT.-2.00GM**

100



7.30MM



6.20MM

US:-7



2.40MM

ROUND.
8X8MM-1PCS (2CT.)

SIEVE SIZE	DIA WT/PC	DIA MM	DIA PCS	DIA WT
3.5-4	0.012	1.40	24	0.29
		Total	24	0.29

14KT WT.-2.70GM
18KT WT.-3.20GM



**PRINCESS.
7X7MM-1CPS (2CT.)**

SIEVE SIZE	DIA WT/PC	DIA MM	DIA PCS	DIA WT
2.5-3	0.010	1.30	24	0.24
		Total	24	0.24

**14KT WT.-2.50GM
18KT WT.-3.00MM**



ROUND.

8X8MM-1PCS (2CT.)

SIEVE SIZE	DIA WT/PC	DIA MM	DIA PCS	DIA WT
2.5-3	0.010	1.30	24	0.24
		Total	24	0.24

14KT WT.-2.70GM

18KT WT.-3.20GM

10.10MM



103



7.00MM



US:-7

1.70MM



1.80MM

ROUND.

8X8MM-1PCS (2CT.)

SIEVE SIZE	DIA WT/PC	DIA MM	DIA PCS	DIA WT
0-00	0.005	1.00	30	0.15
		Total	30	0.15

14KT WT.-2.00GM

18KT WT.-2.50GM



**PRINCESS.
7X7MM-1PCS (2CT.)**

SIEVE SIZE	DIA WT/PC	DIA MM	DIA PCS	DIA WT
2.5-3	0.010	1.30	24	0.24
		Total	24	0.24

**14KT WT.-2.60GM
18KT WT.-3.20GM**



PRINCESS - 7X7MM-1PCS (2.00CT.)

14KT WT.- 2.80GM
18KT WT.- 3.30GM
SILVER WT.- 2.20GM

106



14KT WT.- 2.60GM
18KT WT.- 3.20GM
SILVER WT.- 2.10GM

HEART.- 8X8MM-1PCS (2.00CT.)



107



**ROUND.
8X8MM-1PCS (2CT.)**

**14KT WT.-3.50GM
18KT WT.-4.20GM**

9.00MM



11.60MM



US:-7

1.70MM



2.00MM

PRINCESS DIA:-7.00x7.00MM=1PCS.

14KT WT:-2.90GM

18KT WT:-3.40GM

10.00MM



5.50MM



US:-7

1.70MM



2.00MM

ROUND DIA:-8.00x8.00MM=1PCS.
14KT WT:-4.00GM
18KT WT:-4.90GM

110



1.7mm

27.7
mm

2mm

	Round	Diamond
	8.00 X 8.00	1 1.92tw

14k-2.800gm
18k-3.400gm



ROUND.
8X8MM-1PCS

14KT WT.-2.00GM
18KT WT.-2.40GM



8mm



US-7

1.7mm



27.7 mm

2mm

	Emerald Square	Diamond
	7.00 X 7.00	1 1.78tw

14k-3.700gm
18k-4.400gm



**RADIANT.
8.50X6.50MM-1PCS (2 CT.)**

**14KT WT.-3.40GM
18KT WT.-4.10GM**



	Round 8.00 X 8.00	Diamond 1 1.92tw
---	----------------------	---------------------

14k-3.000gm
18k-3.500gm

















































































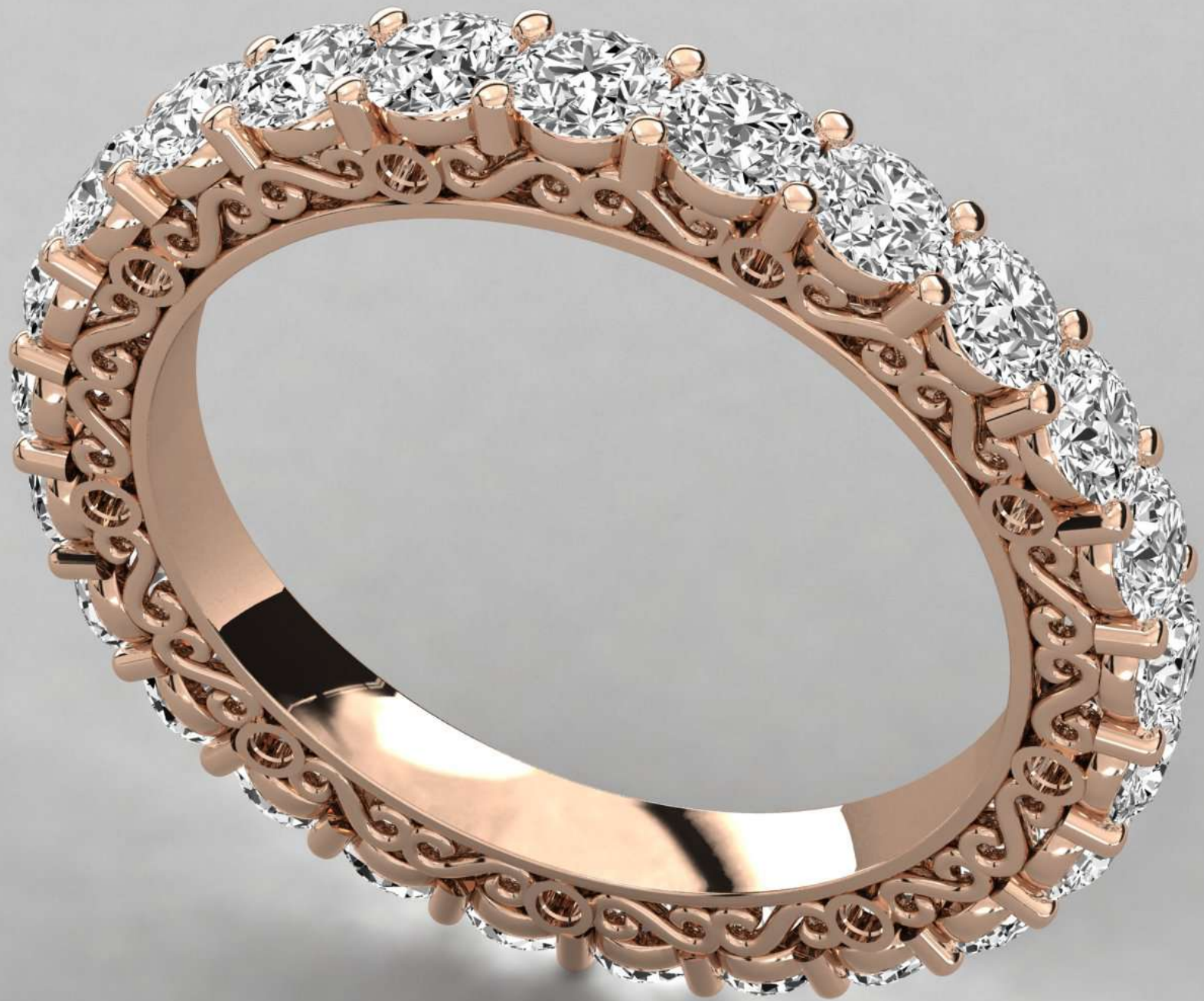

















































































































































































































































































































































































































































Diamonds-
1.10mm, 25 pis
4.60mm, 1 pis

Diamonds Wt-0.51 Cts.
Gold Wt-3.380 Gms.



Diamonds-
1.20mm, 18 pis
5.45mm, 1 pis

Diamonds Wt-6.200 Cts.
Gold Wt-0.72 Gms.



Diamonds-
1.30mm, 7 pis
1.20mm, 14 pis
1.10mm, 8 pis
1.00mm, 2 pis
5.45mm, 1 pis

Diamonds Wt-0.80 Cts.
Gold Wt-4.300 Gms.



Diamonds-
5.45mm, 1 pis

Diamonds Wt-0.60 Cts.
Gold Wt-3.620 Gms.



Diamonds-
5.45mm, 1 pis

Diamonds Wt-0.60 Cts.
Gold Wt-4.000 Gms.



Diamonds-
5.45mm, 1pis
1.10mm, 25 pis

Diamonds Wt-0.72 Cts.
Gold Wt-3.580 Gms.



Diamonds-
1.10mm, 3 pis
1.30mm, 4 pis
1.20mm, 3 pis
5.45mm, 1 pis

Diamonds Wt-0.67 Cts.
Gold Wt-2.990 Gms.



Diamonds-
1.20mm, 14 pis
1.30mm, 8 pis
5.45mm, 1 pis

Diamonds Wt-0.76 Cts.
Gold Wt-3.830 Gms.



Diamonds-
1.20mm, 8 pis
5.45mm, 1 pis

Diamonds Wt-0.65 Cts.
Gold Wt-3.540 Gms.



Diamonds-
1.30mm, 8 pis
1.20mm, 4 pis
1.10mm, 6 pis
5.45mm, 1 pis

Diamonds Wt-0.72 Cts.
Gold Wt-5.500 Gms.



Diamonds-
5.45mm, 1 pis
1.20mm, 8 pis

Diamonds Wt-0.67 Cts.
Gold Wt-4.830 Gms.



Diamonds-
1.30mm, 8 pis
1.20mm, 8 pis

Diamonds Wt-0.72 Cts.
Gold Wt-2.320 Gms.



Diamonds-

1.30mm, 6 pis
1.20mm, 5 pis
1.10mm, 2 pis
1.00mm, 2 pis
5.45mm, 1 pis

Diamonds Wt-0.72 Cts.
Gold Wt-3.920 Gms.



Diamonds-

1.00mm, 2 pis

1.10mm, 4 pis

1.20mm, 4 pis

1.30mm, 10 pis

5.45mm, 1 pis

Diamonds Wt-0.74 Cts.

Gold Wt-3.800 Gms.



Diamonds-
5.45mm,1 pis

Diamonds Wt-0.60 Cts.
Gold Wt-4.000 Gms.



Diamonds-
1.20mm, 4 pis
1.10mm, 16 pis
4.93mm, 1 pis

Diamonds Wt-0.55 Cts.
Gold Wt-3.250 Gms.



Diamonds-
5.45mm, 1 pis
1.10mm, 12 pis

Diamonds Wt-0.66 Cts.
Gold Wt-3.440 Gms.



Diamonds-
1.10mm, 20 pis
1.00mm, 5 pis
5.45mm, 1 pis

Diamonds Wt-0.72 Cts.
Gold Wt-3.550 Gms.



Diamonds-
1.30mm, 4 pis
1.20mm, 14 pis
1.10mm, 2 pis
5.45mm, 1 pis

Diamonds Wt-0.73 Cts.
Gold Wt-3.470 Gms.



Diamonds-
1.10mm, 14 pis
5.45mm, 1 pis

Diamonds Wt-0.67 Cts.
Gold Wt-3.160 Gms.



Diamonds-
1.20mm, 18 pis
5.45mm, 1 pis

Diamonds Wt-0.72 Cts.
Gold Wt-3.080 Gms.



Diamonds-
1.20mm, 20 pis
1.10mm, 8 pis
1.00mm, 8 pis
5.45mm, 1 pis

Diamonds Wt-0.80 Cts.
Gold Wt-3.740 Gms.



Diamonds-
1.20mm, 44 pis
5.45mm, 1 pis

Diamonds Wt-0.89 Cts.
Gold Wt-4.310 Gms.



Diamonds-
1.20mm, 24 pis
5.45mm, 1 pis

Diamonds Wt-0.76 Cts.
Gold Wt-3.330 Gms.



Diamonds-
5.45mm, 1 pis
1.20mm, 12 pis
1.10mm, 4 pis
1.30mm, 4 pis

Diamonds Wt-0.73 Cts.
Gold Wt-3.930 Gms.



Diamonds-
1.50mm, 9 pis
5.45mm, 1 pis

Diamonds Wt-0.70 Cts.
Gold Wt-4.040 Gms.



Diamonds-
1.60mm, 1 pis
5.45mm, 1 pis

Diamonds Wt-0.62 Cts.
Gold Wt-3.130 Gms.



Diamonds-

1.00mm, 4 pis

1.10mm, 2 pis

1.20mm, 4 pis

1.30mm, 12 pis

5.45mm, 1 pis

Diamonds Wt-0.75 Cts.

Gold Wt-3.370 Gms.



Diamonds-
5.45mm, 1 pis

Diamonds Wt-0.60 Cts.
Gold Wt-4.00 Gms.



Diamonds-
1.10mm, 26 pis
5.45mm, 1 pis

Diamonds Wt-0.73 Cts.
Gold Wt-3.450 Gms.



Diamonds-
1.10mm, 30 pis
5.45mm, 1 pis

Diamonds Wt-0.75 Cts.
Gold Wt-4.440 Gms.



Diamonds-
5.45mm, 1 pis

Diamonds Wt-0.60 Cts.
Gold Wt-3.640 Gms.



Diamonds-
5.45mm, 1 pis
1.10mm, 17 pis

Diamonds Wt-0.69 Cts.
Gold Wt-4.110 Gms.



Diamonds-
5.45mm, 1 pis

Diamonds Wt-0.60 Cts.
Gold Wt-3.650 Gms.



Diamonds-
5.45mm, 1 pis
1.30mm, 8 pis
1.10mm, 15 pis

Diamonds Wt-0.74 Cts.
Gold Wt-4.180 Gms.



Diamonds-
5.49mm, 1 pis

Diamonds Wt-0.54 Cts.
Gold Wt-4.120 Gms.



Diamonds-
5.45mm, 1 pis
1.30mm, 18 pis

Diamonds Wt-0.75 Cts.
Gold Wt-3.450 Gms.



Diamonds-
5.45mm, 1 pis
1.10mm, 12 pis
1.40mm, 6 pis

Diamonds Wt-0.71 Cts.
Gold Wt-3.900 Gms.



Diamonds-
5.45mm, 1 pis
1.20mm, 20 pis
1.30mm, 8 pis
1.10mm, 6 pis

Diamonds Wt-0.83 Cts.
Gold Wt-3.640 Gms.



Diamonds-
5.45mm, 1 pis
1.20mm, 16 pis

Diamonds Wt-0.70 Cts.
Gold Wt-4.340 Gms.



Diamonds-
5.45mm, 1 pis
1.20mm, 12 pis

Diamonds Wt-0.68 Cts.
Gold Wt-4.040 Gms.



Diamonds-
5.45mm, 1 pis
1.20mm, 38 pis

Diamonds Wt-0.85 Cts.
Gold Wt-5.190 Gms.



Diamonds-
5.45mm, 1 pis
1.10mm, 44 pis

Diamonds Wt-0.82 Cts.
Gold Wt-4.990 Gms.



Diamonds-
5.45mm, 1 pis
1.10mm, 16 pis
1.20mm, 6 pis
1.30mm, 8 pis

Diamonds Wt-0.79 Cts.
Gold Wt-3.270 Gms.



Diamonds-
5.45mm, 1 pis
1.10mm, 28 pis

Diamonds Wt-0.74 Cts.
Gold Wt-3.480 Gms.



Diamonds-
5.45mm, 1 pis
1.40mm,38 pis

Diamonds Wt-0.99 Cts.
Gold Wt-4.360 Gms.



Diamonds-
5.45mm, 1 pis
1.20mm, 25 pis

Diamonds Wt-0.76 Cts.
Gold Wt-3.430 Gms.



Diamonds-
5.45mm, 1 pis
1.20mm, 18 pis
1.30mm, 24 pis
1.10mm, 4 pis

Diamonds Wt-0.94 Cts.
Gold Wt-6.040 Gms.



Diamonds-
5.45mm, 1 pis

Diamonds Wt-0.60 Cts.
Gold Wt-3.700 Gms.



Diamonds-
5.45mm, 1 pis
1.00mm, 4 pis
1.10mm, 40 pis

Diamonds Wt-0.70 Cts.
Gold Wt-4.00 Gms.



Diamonds-
1.50mm, 1 pis
5.45mm, 1 pis

Diamonds Wt-0.61 Cts.
Gold Wt-3.190 Gms.



Diamonds-
5.45mm, 1 pis
1.40mm, 2 pis

Diamonds Wt-0.62 Cts.
Gold Wt-3.740 Gms.



Diamonds-
1.20mm, 9 pis
5.45mm, 1 pis

Diamonds Wt-0.66 Cts.
Gold Wt-3180 Gms.



Diamonds-
5.45mm, 1 pis

Diamonds Wt-0.60 Cts.
Gold Wt-4.700 Gms.



Diamonds-
5.45mm, 1 pis
1.00mm, 6 pis
1.20mm, 28 pis

Diamonds Wt-0.81 Cts.
Gold Wt-3.720 Gms.



Diamonds-
5.45mm, 1 pis
1.30mm, 8 pis
1.20mm, 8 pis
1.10mm, 8 pis

Diamonds Wt-0.76 Cts.
Gold Wt-4.100 Gms.



Diamonds-
5.45mm, 1 pis
1.10mm, 40 pis

Diamonds Wt-0.80 Cts.
Gold Wt-4.050 Gms.



Diamonds-
1.50mm, 12 pis
5.45mm, 1 pis
1.20mm, 8 pis
1.30mm, 12 pis

Diamonds Wt-0.88 Cts.
Gold Wt-3.900 Gms.



Diamonds-
5.45mm, 1 pis
1.20mm, 17 pis
1.20mm, 3 pis

Diamonds Wt-0.73 Cts.
Gold Wt-5.170 Gms.



Diamonds-
5.45mm, 1 pis
1.30mm, 8 pis
1.20mm, 6 pis

Diamonds Wt-0.72 Cts.
Gold Wt-4.060 Gms.



Diamonds-
1.50mm, 15 pis
1.20mm, 6 pis
1.30mm, 16 pis
1.40mm, 6 pis

Diamonds Wt-0.42 Cts.
Gold Wt-5.00 Gms.



Diamonds-
1.40mm, 65 pis
1.30mm, 16 pis
1.20mm, 4 pis
1.50mm, 1 pis

Diamonds Wt-0.84 Cts.
Gold Wt-5.070 Gms.



Diamonds-
1.40mm, 9 pis
1.30mm, 20 pis

Diamonds Wt-0.24 Cts.
Gold Wt-5.300 Gms.



Diamonds-
1.40mm, 49 pis
1.0mm, 14 pis
1.50mm, 1 pis

Diamonds Wt-0.63 Cts.
Gold Wt-5.320 Gms.



Diamonds-
1.40mm, 33 pis
1.50mm, 25 pis
1.30mm, 32 pis

Diamonds Wt-0.92 Cts.
Gold Wt-5.100 Gms.



Diamonds-
1.40mm, 37 pis
1.30mm, 16 pis
1.50mm, 1 pis

Diamonds Wt-0.52 Cts.
Gold Wt-5.210 Gms.



Diamonds-
1.30mm, 10 pis
1.20mm, 4 pis
1.40mm, 58 pis
1.50mm, 11 pis

Diamonds Wt-0.84 Cts.
Gold Wt-4.710 Gms.



Diamonds-

1.40mm, 22 pis

1.50mm, 5 pis

1.60mm, 12 pis

1.30mm, 8 pis

1.20mm, 4 pis

1.10mm, 4 pis

Diamonds Wt- 0.59 Cts.

Gold Wt- 3.900 Gms.



Diamonds-
1.40mm, 9 pis
1.30mm, 20 pis

Diamonds Wt-0.24 Cts.
Gold Wt-4.300 Gms.



Diamonds-
1.40mm,23 pis
1.50mm, 9 pis

Diamonds Wt-0.35 Cts.
Gold Wt-7.800 Gms.



Diamonds-
1.40mm, 61 pis
1.50mm, 1 pis

Diamonds Wt-0.64 Cts.
Gold Wt-3.430 Gms.



Diamonds-
1.40mm, 57 pis
1.80mm, 5 pis
1.60mm, 1 pis

Diamonds Wt-0.72 Cts.
Gold Wt-5.320 Gms.



Diamonds-
1.20mm, 7 pis
1.30mm, 18 pis
1.40mm, 16 pis
1.50mm, 1 pis
2.00mm, 1 pis

Diamonds Wt-0.40 Cts.
Gold Wt-4.500 Gms.



Diamonds-
1.40mm, 30 pis
1.50mm, 1 pis
1.70mm, 4 pis
1.60mm, 2 pis
1.30mm, 8 pis
1.20mm, 2 pis

Diamonds Wt-0.50 Cts.
Gold Wt-5.140 Gms.



Diamonds-

- 1.50mm, 5 pis
- 1.40mm, 25 pis
- 1.20mm, 8 pis
- 1.30mm, 12 pis
- 1.60mm, 4 pis

Diamonds Wt-0.53 Cts.

Gold Wt-5.00 Gms.



Diamonds-
1.30mm, 6 pis
1.40mm, 20 pis
1.50mm, 1 pis

Diamonds Wt-0.27 Cts.
Gold Wt-2.760 Gms.



Diamonds-
1.40mm, 46 pis
1.50mm, 1 pis

Diamonds Wt-0.48 Cts.
Gold Wt-5.450 Gms.



Diamonds-
1.30mm, 25 pis
1.40mm, 24 pis
1.50mm, 6 pis

Diamonds Wt-0.53 Cts.
Gold Wt-4.780 Gms.



Diamonds-
1.90mm, 2 pis
1.30mm, 40 pis
1.40mm, 29 pis
1.50mm, 1 pis

Diamonds Wt-0.69 Cts.
Gold Wt-6.340 Gms.



Diamonds-
1.40mm, 21 pis
1.50mm, 1 pis

Diamonds Wt-0.23 Cts.
Gold Wt-4.400 Gms.



Diamonds-
1.40mm, 38 pis
1.50mm, 1 pis

Diamonds Wt-0.40 Cts.
Gold Wt-4.720 Gms.



Diamonds-
1.40mm, 46 pis
1.30mm, 16 pis
1.50mm, 1 pis

Diamonds Wt-0.62 Cts.
Gold Wt-3.620 Gms.



Diamonds-
1.40mm, 21 pis
1.50mm, 1 pis

Diamonds Wt-0.23 Cts.
Gold Wt-4.510 Gms.



Diamonds-
1.30mm, 20 pis
1.40mm, 9 pis

Diamonds Wt-0.24 Cts.
Gold Wt-3.900 Gms.



Diamonds-
1.50mm, 1 pis
1.40mm, 21 pis
1.30mm, 63 pis

Diamonds Wt-0.75 Cts.
Gold Wt-4.330 Gms.



Diamonds-
1.30mm, 24 pis
1.20mm, 2 pis
1.50mm, 1 pis
1.40mm, 21 pis

Diamonds Wt-0.44 Cts.
Gold Wt-4.110 Gms.



Diamonds-
1.30mm, 80 pis
1.40mm, 13 pis

Diamonds Wt-0.77 Cts.
Gold Wt-5.00 Gms.



Diamonds-
1.30mm, 28 pis
1.20mm, 2 pis
1.40mm, 16 pis

Diamonds Wt-0.41 Cts.
Gold Wt-3.810 Gms.



Diamonds-
1.60mm, 6 pis
1.70mm, 1 pis
1.30mm, 62 pis
1.20mm, 6 pis

Diamonds Wt-0.66 Cts.
Gold Wt-7.720 Gms.



Diamonds-
1.50mm, 32 pis
1.40mm, 37 pis
1.20mm, 12 pis

Diamonds Wt-0.88 Cts.
Gold Wt-6.300 Gms.



Diamonds-
1.50mm, 9 pis
1.40mm, 10 pis
1.60mm, 12 pis
1.30mm, 21 pis

Diamonds Wt-0.57 Cts.
Gold Wt-2.720 Gms.



Diamonds-
1.50mm, 13 pis
1.40mm, 8 pis
2.00mm, 2 pis
1.30mm, 21 pis

Diamonds Wt-0.45 Cts.
Gold Wt-3.570 Gms.



Diamonds-
1.50mm, 5 pis
1.40mm, 6 pis
1.30mm, 29 pis
1.60mm, 2 pis
1.70mm, 4 pis
1.20mm, 6 pis

Diamonds Wt-0.51 Cts.
Gold Wt-4.00 Gms.



Diamonds-
1.20mm, 8 pis
1.30mm, 32 pis
1.40mm, 6 pis
1.50mm, 1 pis

Diamonds Wt-0.39 Cts.
Gold Wt-3.700 Gms.



Diamonds-
1.40mm, 6 pis
1.50mm, 1 pis
1.30mm, 16 pis

Diamonds Wt-0.21 Cts.
Gold Wt-3.750 Gms.



Diamonds-
1.40mm, 9 pis
1.30mm, 84 pis
1.20mm, 10 pis

Diamonds Wt-0.85 Cts.
Gold Wt-4.560 Gms.



Diamonds-
1.20mm, 8 pis
1.30mm, 8 pis
1.40mm, 18 pis
1.50mm, 6 pis
1.60mm, 1 pis

Diamonds Wt-0.39 Cts.
Gold Wt-3.500 Gms.



Diamonds-
1.20mm, 12 pis
1.30mm, 52 pis
1.40mm, 9 pis

Diamonds Wt-0.58 Cts.
Gold Wt-4.900 Gms.



Diamonds-
1.50mm, 9 pis
1.40mm, 21 pis

Diamonds Wt-0.33 Cts.
Gold Wt-4.820 Gms.



Diamonds-
1.40mm, 27 pis
1.30mm, 8 pis
1.20mm, 2 pis

Diamonds Wt-0.45 Cts.
Gold Wt-4.490 Gms.



Diamonds-
1.30mm, 20 pis
1.40mm, 9 pis

Diamonds Wt-0.24 Cts.
Gold Wt-5.050 Gms.



Diamonds-
1.40mm, 45 pis
1.30mm, 19 pis
1.20mm, 3 pis
1.50mm, 1 pis

Diamonds Wt-0.65 Cts.
Gold Wt-5.460 Gms.



Diamonds-
1.60mm, 8 pis
1.50mm, 2 pis
1.40mm, 11 pis
1.30mm, 38 pis
1.20mm, 54 pis

Diamonds Wt-0.74 Cts.
Gold Wt-5.430 Gms.



Diamonds-
1.40mm, 45 pis
1.50mm, 1 pis
1.30mm, 8 pis

Diamonds Wt-0.54 Cts.
Gold Wt-5.100 Gms.



Diamonds-
1.40mm, 65 pis
1.30mm, 16 pis
1.50mm, 1 pis

Diamonds Wt-0.81 Cts.
Gold Wt-4.590 Gms.



Diamonds-
1.20mm, 9 pis
1.10mm, 2 pis
1.30mm, 26 pis

Diamonds Wt-0.28 Cts.
Gold Wt-4.370 Gms.



Diamonds-
1.60mm, 9 pis
1.30mm, 22 pis
1.40mm, 2 pis

Diamonds Wt-0.34 Cts.
Gold Wt-5.700 Gms.



Diamonds-
1.50mm, 1 pis
1.40mm, 18 pis

Diamonds Wt-0.20 Cts.
Gold Wt-3.510 Gms.



Diamonds-
1.20mm, 26 pis
1.30mm, 24 pis
1.40mm, 31 pis
1.10mm, 4 pis
1.50mm, 1 pis

Diamonds Wt-0.72 Cts.
Gold Wt-4.220 Gms.



Diamonds-

- 1.20mm, 4 pis
- 1.30mm, 31 pis
- 1.10mm, 1 pis
- 1.40mm, 21 pis
- 1.50mm, 1 pis

Diamonds Wt-0.51 Cts.
Gold Wt-4.160 Gms.



Diamonds-
1.50mm, 1 pis
1.40mm, 6 pis
1.30mm, 24 pis

Diamonds Wt-0.27 Cts.
Gold Wt-6.610 Gms.



Diamonds-
1.50mm, 1 pis
1.40mm, 21 pis
1.30mm, 120 pis

Diamonds Wt-1.22 Cts.
Gold Wt-5.100 Gms.



Diamonds-
1.40mm, 49 pis
1.50mm, 3 pis
1.20mm, 8 pis
1.30mm, 8 pis

Diamonds Wt-0.66 Cts.
Gold Wt-5.030 Gms.



Diamonds-
1.40mm, 21 pis
1.50mm, 1 pis
1.20mm, 17 pis
1.30mm, 64 pis

Diamonds Wt-0.87 Cts.
Gold Wt-4.060 Gms.



Diamonds-
1.40mm, 21 pis
1.50mm, 1 pis
1.30mm, 144 pis

Diamonds Wt-1.42 Cts.
Gold Wt-5.820 Gms.



Diamonds-

1.40mm, 6 pis

1.50mm, 1 pis

1.20mm, 20 pis

1.30mm, 80 pis

1.10mm, 16 pis

Diamonds Wt-0.94 Cts.

Gold Wt-4.720 Gms.



Diamonds-
1.20mm, 14 pis
1.30mm,70 pis
1.10mm, 2 pis
1.80mm, 2 pis
1.70mm, 12 pis

Diamonds Wt-0.93 Cts.
Gold Wt-6.520 Gms.



Diamonds-
1.50mm, 9 pis
1.40mm, 21 pis
1.60mm, 4 pis
1.30mm, 18 pis

Diamonds Wt-0.54 Cts.
Gold Wt-5.400 Gms.



Diamonds-

- 1.40mm, 60 pis
- 1.50mm, 24 pis
- 1.30mm, 11 pis
- 1.00mm, 3 pis
- 1.10mm, 2 pis
- 1.60mm, 4 pis
- 1.70mm, 1 pis
- 1.20mm, 1 pis

Diamonds Wt-1.12 Cts.

Gold Wt-6.700 Gms.



Diamonds-
1.50mm, 3 pis
1.40mm, 63 pis
1.30mm, 13 pis
1.20mm, 8 pis

Diamonds Wt-0.84 Cts.
Gold Wt-6.810 Gms.